

U800-MCOLC

RZUT Z GÓRY

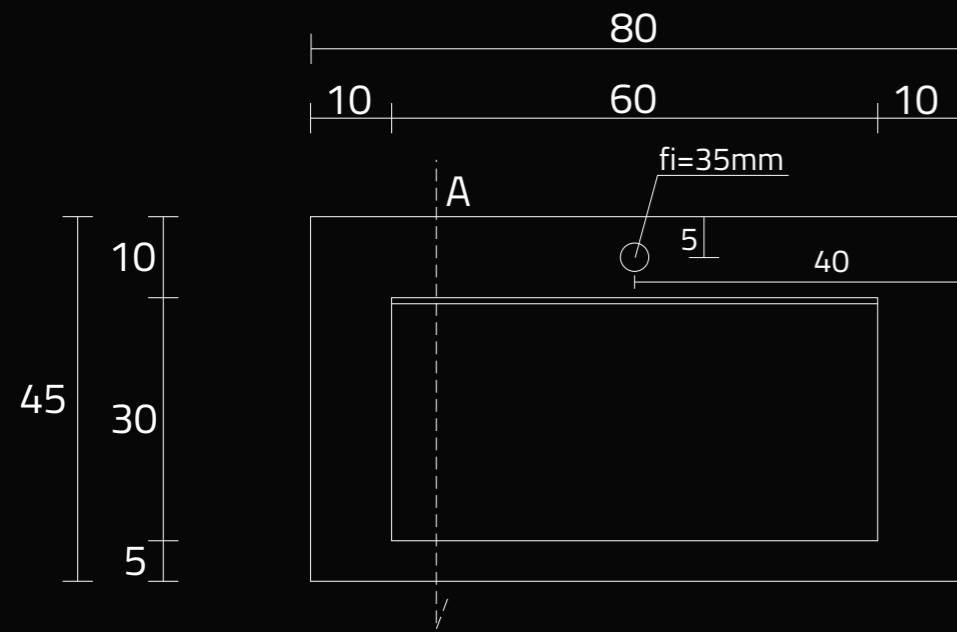

WIDOK Z PRZODU

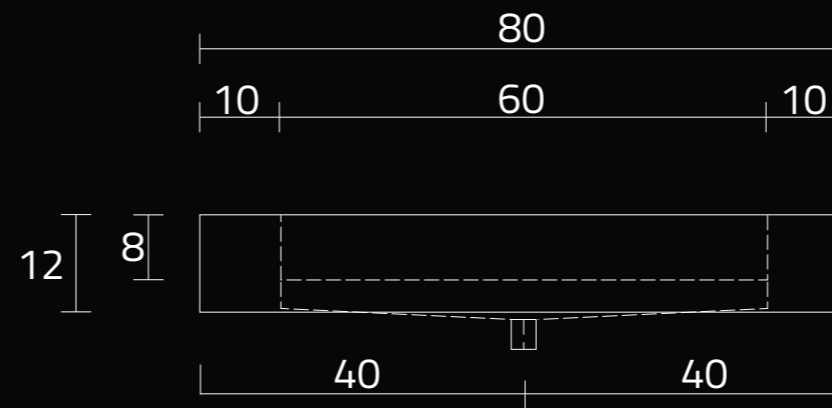

PRZEKRÓJ ,A'

