

U1100-MCOLC/CR

RZUT Z GÓRY

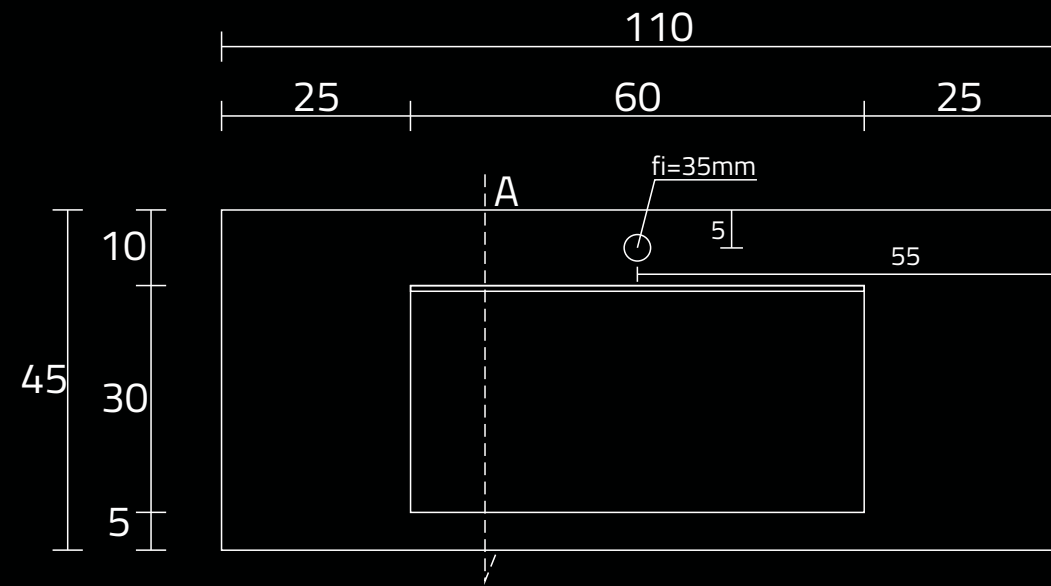

WIDOK Z PRZODU



PRZEKRÓJ ,A'

